

1. Name and Parts

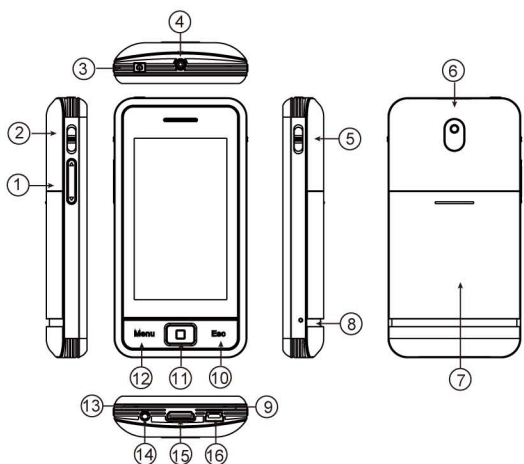

1. Left right button
2. REC/Stop
3. Power button
4. Camera Lens
5. Vibration On/Off
6. Disguised lens
7. Battery cover
8. Reset
9. Rec LED
10. ESC button
11. Enter
12. Menu
13. Power/Charge LED
14. Earphone socket
15. HDMI port
16. Mini USB socket

(1)

2. Package Content

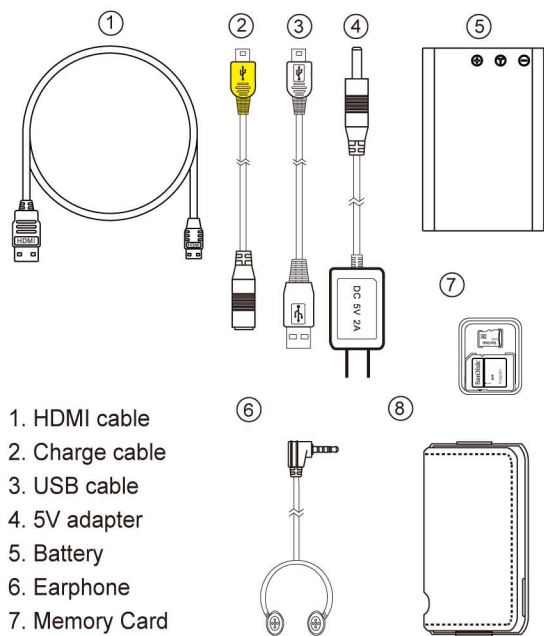

1. HDMI cable
2. Charge cable
3. USB cable
4. 5V adapter
5. Battery
6. Earphone
7. Memory Card
8. Protect Case

(2)

3. Insert Battery and Memory Card

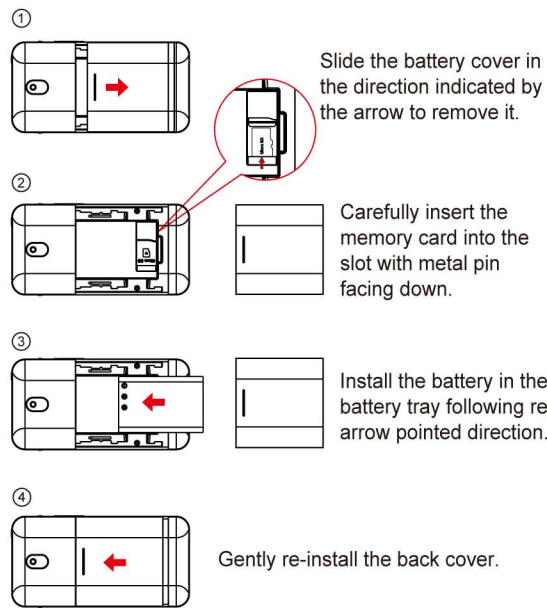

Slide the battery cover in the direction indicated by the arrow to remove it.

Carefully insert the memory card into the slot with metal pin facing down.

Install the battery in the battery tray following red arrow pointed direction.

Gently re-install the back cover.

Note:
Please be careful when inserting, removing, or handling the memory card.

(3)

4. Charging Battery

There are two ways to charge battery.

① Charge by DC adapter

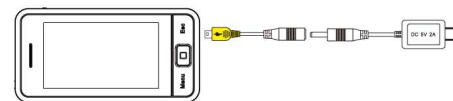

1. Connect the yellow end of the charge cable to the mini USB socket.
2. Plug the DC adapter to a wall outlet, then connect the other end of the power cord to the charge cable. The LED indicator illuminates green indicating the device is in charging mode.

② Charge by USB cable



1. Connect the USB cable to the mini USB socket (16) and connect the other end to PC/laptop. The LED indicator illuminates green indicating the device is in charging mode.

LED Indicator Bar

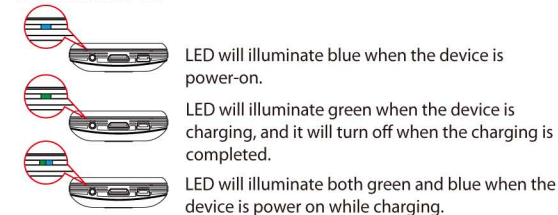

LED will illuminate blue when the device is power-on.

LED will illuminate green when the device is charging, and it will turn off when the charging is completed.

LED will illuminate both green and blue when the device is power on while charging.

(4)

5. Setting

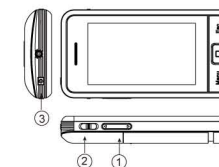

1. Switch ② to Stop before turning on.
2. Press ③ to power on the device.
3. Press Menu ⑫ for 2 seconds.
4. Use ① to select up/down.
5. Press ⑪ to enter the page.
6. Press ⑩ to exit the page.

SETUP

PLAYBACK	ON
MOTION DET	ON
LANGUAGE	ENGLISH
TV FORMAT	NTSC
VIDEO SIZE	1280X720
PHOT SIZE	SM
MIC	ON
DATE	2012.06.18
CLOCK	15:22
STAMP	ON
OVER WRITE	300M
BURST	3 PICS
FORMAT	NO
SYS. RESET	NO
VERSION	V20120207

◀ SELECT

○ ENTER

(5)

Available at www.spygeargadgets.com

6. Recording Operation

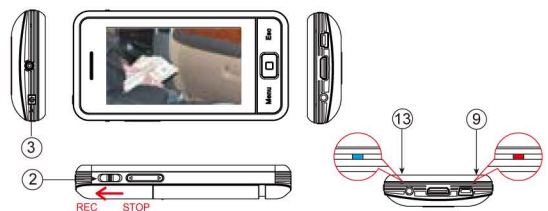

1. Long press ③ to switch on the device.
2. Following the red arrow pointed direction, switch to Rec ② to start recording.
3. To stop recording, switch to STOP ②.
4. When the device is turned on, LED ⑬ will illuminate blue.
5. During recording, the Rec LED ⑨ will illuminate red.

6.1. Spy Mode

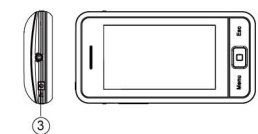

Press the power button one time to turn the device into spy mode. The display will be off during recording. Press the power button again to turn on the display.

(6)

6.2. Vibration ON/OFF

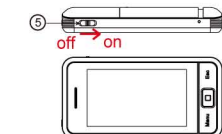

Turn the vibration mode on by switching to red arrow pointed direction.

6.3. Motion Detect

Enter Menu page and turn on Motion Detect. Switch to Rec, the DVR will start to record when the movement of an object/person is detected. In motion detect mode, the recording will stop when the file size reaches 300mb.

7. Playback Video File On Unit

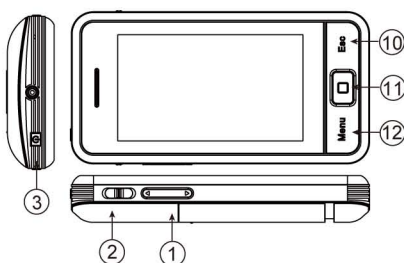

1. Switch REC/Stop button ② to Stop position.
2. Press Power button ③ to switch on the device.
3. Press Menu ⑫ for 2 second to enter the menu page.
4. Select Playback and switch to On.
5. Press Left right button ① to choose video file.
6. Left right button ① serves as volume+/- button while playing the video.
7. Press Esc button ⑩ to return to photo/video playlist.

(7)

8. Playback on PC/Notebook/Monitor

8.1. Connect to PC by USB cable

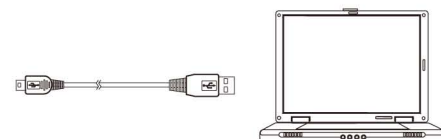

8.2. Connect to monitor by HDMI cable

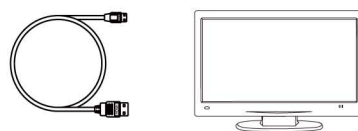

8.3. Playback on PC/Notebook with memory card

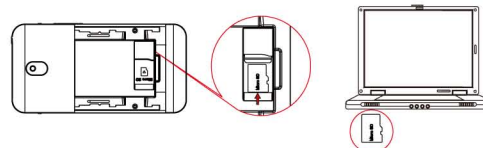

(8)

9. Photo Shooting Operation

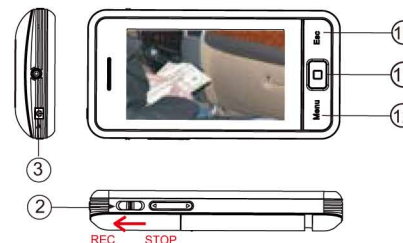

1. Switch to REC and press enter ⑪ to take snapshot.
2. The device will vibrate during snapshot (when the vibration mode is turned on.)
3. Long press Menu ⑫, and choose playback/on to enter the photo playlist.
4. Press Esc ⑩ to return to menu page.

10. Zoom In/Out setting

Camera lens zoom in/out is functionable only when the video size is 720P (1280 X 720). Edit setting from Menu → Video Size → 1280x720

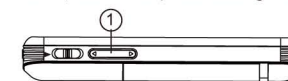

Press left right button ① to zoom in/out.

(9)

Cellphone Design Portable DVR Quick Guide

